



**HEAT & GLO™**

Where everything comes together



**6000 Series**  
Direct Vent Gas Fireplaces



A



B

The best  
& brightest



C

**Cover: 6000GLX** shown with Portico mantel in chocolate maple, black granite with curved hearth and Galleria operable doors in new bronze finish

**A. 6000GL** shown with Sonoma mantel in ginger knotty alder, cross-cut travertine and Valencia operable doors in aged brass finish

**B. 6000GLX** shown with Cornerstone surround, Cultured Stone's Chardonnay Limestone and Chateau Deluxe front in new bronze finish

**C. 6000GL** shown with Hearst cast mantel, cast stone hearth and insert panels, and Halston front in graphite finish

It's the one that started a revolution. In 1987, the 6000 Series introduced direct vent technology, making it the most sought after gas fireplace on the market. Today, the 6000 Series still combines beautiful design with the latest innovations, plus an impressive selection of mantels, fronts and finishes. All at a range of prices—for every type of project and any size budget. The best just keeps getting better.



**6000GLX**, our exceptional luxury model, comes standard with all the Series' features: 3-burner system with dual Flame-Out-of-Log burners and the fully concealed Mystifire® burner, our patented accent lighting system and our most advanced wall control, the IntelliSwitch300.

**6000GL** includes many 6000 Series upgrades as standard features: 2-burner system with single Flame-Out-of-Log burner and the fully concealed Mystifire burner, and the IntelliSwitch200 wall control.

**6000GLX** shown with Portico mantel in chocolate maple, black granite with curved hearth and Arcadia front in new bronze finish

# 6000 Series

Best-in-class design and features



**6000G** shown with Parsons mantel in chocolate knotty alder, cross-cut travertine and Halston operable doors in graphite finish

**6000GCF** delivers clean face design plus a flush hearth installation option, for the seamless, masonry-like finish usually found with more expensive fireplaces.

**6000G** is perfect for more moderate budgets. It's the ideal combination of technology, features and price.



**6000GCF** shown with Cultured Stone's Ohio Cobblefield and Firescreen front in black finish

# Finishes

Four rich finishes. High on style, long on durability.

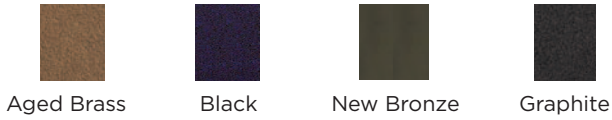

Options, options  
& more options

## Overlap Fronts\* 6000GLX, 6000GL & 6000G

Now our fronts and operable doors completely overlap surround materials, for the cleanest look yet. Plus, adjustable hinges allow for variations in thickness of surround materials up to 1". So when it comes to clean, beautiful design, nobody does it better.

**Arcadia Front**

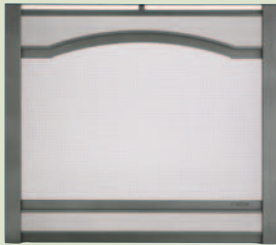

ARCADIA-36

**Chateau Deluxe Front**



CHAD-36

**Galleria Operable Doors**



GALLERIA-36

**Halston Operable Doors**



HALSTON-36

**Valencia Operable Doors**

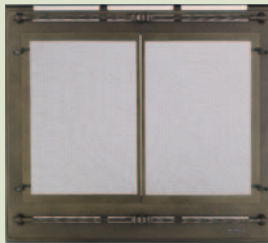

VALENCIA-36

**Folio Front (Inside Fit)**



(Does not overlap)  
FOLIO-36

\*All fronts ship standard with vanity panel

## 6000GCF Firescreen Front & Firescreen Companions

The firescreen front can be purchased alone or with one of these three firescreen companions to attach to the front's exterior. Each is available in black, bronze or pewter.

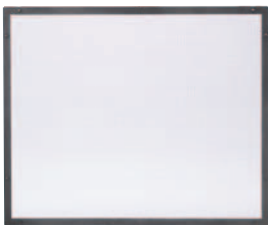

**Firescreen Front**  
DF-6-CFFS



**Arbor Creek**



**Carriage Hill**

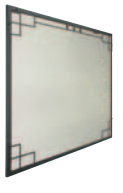
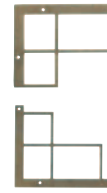

**Prairie Ridge**

# Mantel Options

The 6000 Series has a complete look right for any home. Shown are a few from our impressive selection.



Parsons in chocolate knotty alder (6000G)



Sonoma in ginger knotty alder (6000GL)



Hearst cast mantel (6000GL)



Portico in painted maple (6000GLX)



Cornerstone (6000GLX)

# Wood Species & Finishes

Three types of wood and three finishes give you nine ways to find your perfect match. Also available unfinished.



Knotty Alder Natural



Knotty Alder Ginger



Knotty Alder Chocolate



Maple Natural



Maple Ginger



Maple Chocolate



Oak Natural



Oak Ginger

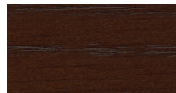

Oak Chocolate

# Portico Mantel Features

The Portico mantel features an open arch design that can be finished one of three ways.



Inset finished to match mantel

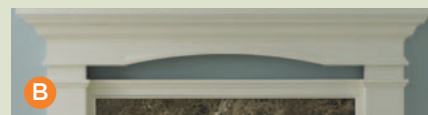

Inset painted to match wall color



Granite Inset



Set 8 curved hearth (shown in Green Granite)

# Granite & Marble Options

Complete your hearth system with a traditional rectangular shape or one that is curved to match the arched inset of the Portico mantel.



Absolute Black Granite

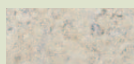

Cross-cut Travertine



Green Granite



Impala Black Granite



Marron Brown Marble

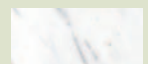

White Marble

# Advanced Technologies

The 6000 Series is loaded with state-of-the-art, patented innovations.



**1 Flame-Out-of-Log Technology**  
Adds another burner inside of the logs, providing a more realistic flame appearance and better flame height.

**2 Mystifire Burner**  
Concealed, multi-level, textured burner molded directly into the hearth refractory. Improves flame height, eliminates metal burner, and best replicates a woodburning ash bed.

**3 Accent Lighting**  
Adds year-round ambience with or without the fire.

**4 IntelliSwitch Controls**  
User-friendly controls let you operate fireplace functions without going underneath the fireplace.



Our advanced technologies let us create different flame "ages" and looks.



**A younger fire** with yellow flames concentrated in the center of the box with less glow

### 6000G and 6000GCF

Mystifire burner and 30,000 Btu/Hour input



**A maturing fire** with spreading flames, plus more glow on the logs and embers

### 6000GL

Single Flame-Out-of-Log burner plus Mystifire burner and 30,000 Btu/Hour input



**A very mature fire,** blending larger flames with lots of glow spread throughout the firebox

### 6000GLX

Dual Flame-Out-of-Log burners, Mystifire burner and 40,000 Btu/Hour input

## Heat-Zone®

Optional Heat-Zone climate control system turns your fireplace into a flexible, energy-saving heat source by transferring excess heat from your fireplace to other locations in your home.

**Not available on 6000GCF.**

## Heat Duct

Optional Heat Duct system improves furnace efficiency and room comfort by pulling excess heat away from the fireplace, out of the hearth room and into your furnace's cold air return ducting.

**Not available on 6000GCF.**

## Limited Lifetime Warranty\*

The strongest in the industry, Heat & Glo provides a lifetime warranty on the most important aspects of the fireplace: fiber logs, stainless steel burner, firebox and heat exchanger.

## IntelliFire™

Our exclusive, state-of-the-art IntelliFire ignition system reduces gas consumption and thermogenerator wear by providing a pilot flame only when needed. Also supplies a backup battery system to run the fireplace during a power outage.

## Healthy Hearth

Our direct vent fireplaces feature a sealed combustion chamber that draws in fresh air from outdoors and discards all combustion by-products back outside. Recognized by the American Lung Association® Health House® program as a Clean Air Choice.™

## Direct Venting System

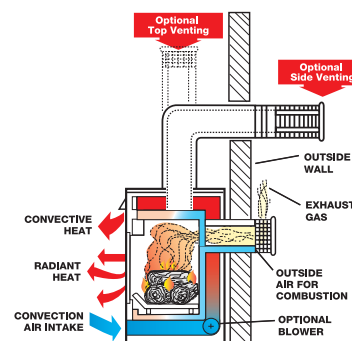

\*For full warranty details, go to [www.heatnglo.com](http://www.heatnglo.com)

# 6000 Series Specifications

MODEL	HEIGHT		FRONT WIDTH		BACK WIDTH		DEPTH		GLASS SIZE	Btu/Hour Input		
	Actual	Framing	Actual	Framing	Actual	Framing	Actual	Framing		6000GLX	6000GL	6000G
6000GLX 6000GL 6000G	38	38-1/2	41	42	28-1/2	42	21-1/2	22	36 x 24-3/4	18,700-40,000	19,000-30,000	18,200-30,000

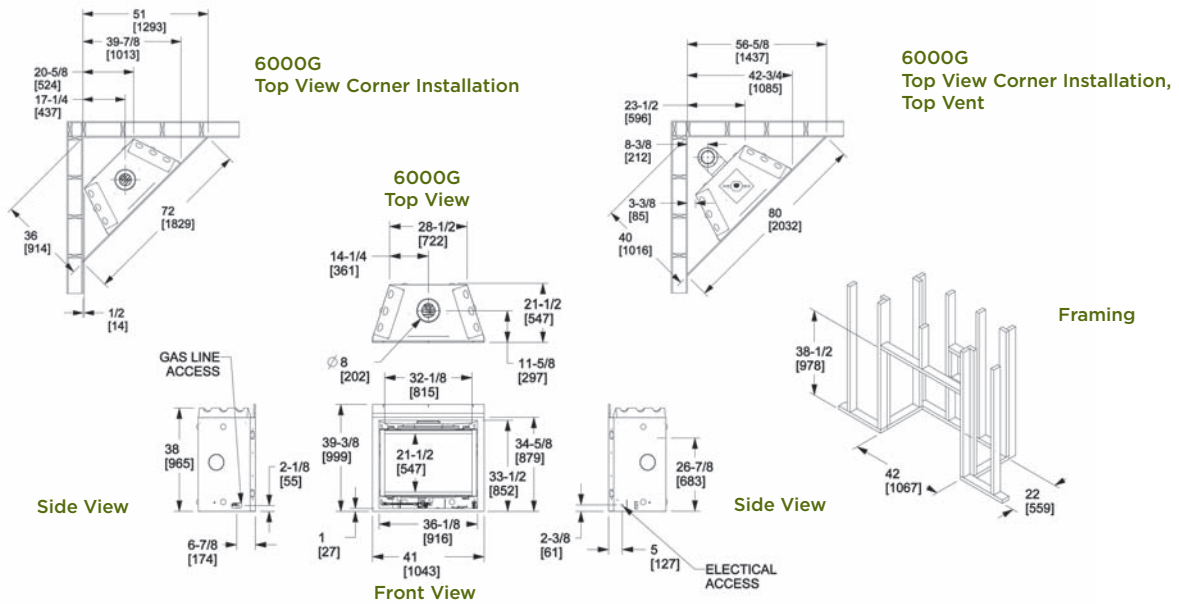

MODEL	HEIGHT		FRONT WIDTH		BACK WIDTH		DEPTH		GLASS SIZE	Btu/Hour Input
	Actual	Framing	Actual	Framing	Actual	Framing	Actual	Framing		
6000GCF	38	44-3/4	41-1/8	42	28-1/2	42	21-1/2	22	36 x 24-3/4	20,000-30,000

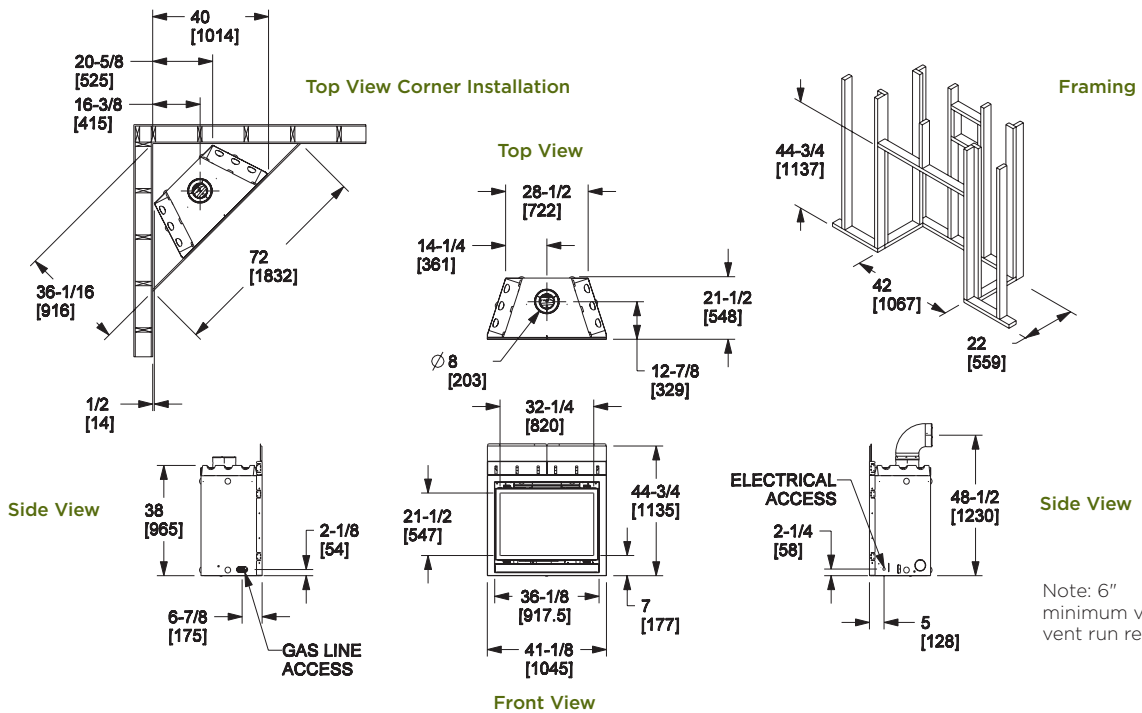

Note: 6" minimum vertical vent run required

Dimensions above are in inches. Reference dimensions only. We recommend measuring individual units at installation. Assumes the use of 1/2" drywall. NOTE: Combustible material should not be installed over the face. Make sure you do NOT cover the decorative door opening.

Refer to installation manual for detailed specifications on installing this product. Heat & Glo reserves the right to update units periodically. The flame and ember appearance may vary based on the type of fuel burned and the venting configuration used. Pictures in this brochure are not a true representation of the fireplace and/or flames.



FEATURES	6000GLX	6000GL	6000G	6000GCF
Variable Btu/Hour Input (NG)	40,000-18,700	30,000-19,000	30,000-18,200	30,000-20,000
Ignition System	IntelliFire™	IntelliFire	IntelliFire or Standing Pilot	IntelliFire
Flame-Out-of-Log Technology*	Adjustable	X	NA	NA
Mystifire Burner	X	X	X	X
Accent Lighting*	Adjustable	Optional	NA	NA
Included Controls**	IntelliSwitch300	IntelliSwitch200	On/Off Rocker Switch on Unit (optional)	Optional
4-Piece Brick Refractory Kit	Stratford or School House Red	NA	NA	NA
3-Piece Brick Refractory Kit	NA	Stratford or School House Red	Optional	Stratford (School House Red optional)
AFUE Rated (Ceramic Glass)	X	NA	NA	NA
Heater Rated	X	X	X	X
Fan Kit w/Speed Control	X	Optional	Optional	Optional
Heat-Zone® Option	X	X	X	NA
Heat Duct Option	X	X	X	NA
Gas Flex Connector	X	X	X	X

\* Requires the IntelliSwitch300 to operate Flame-Out-of-Log Technology or accent lighting.

\*\* Remote control and other wall switches available. Remote control will not operate all features on 6000GLX.



For complete information and valuable assistance on this series, please contact us at:

Heat & Glo

A brand of Hearth & Home Technologies Inc.

20802 Kensington Boulevard, Lakeville, MN 55044

(888) 427-3973 (952) 985-6000

Email: [info@heatnglo.com](mailto:info@heatnglo.com)

Web: [heatnglo.com](http://heatnglo.com)

HNG-1003U-0606